

- Ⓘ **Gamma TRINCIATRICI**
- Ⓖ **Range FLAILMOWERS**
- Ⓕ **Gamme BROYEURS**

TrisaR

TriLat

TrisToc



Pag. 5



Pag. 6



Pag. 7



Pag. 13

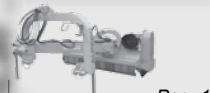

Pag. 14



Pag. 15



Pag. 20

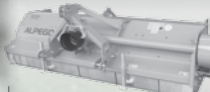

Pag. 21

# TrisaR

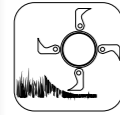

Trinciatrici polivalenti ALPEGO, sono lo strumento ideale per lavorare in tutte le situazioni, con ottimi risultati e massima sicurezza; per tagliare erba, trinciare sarmenti e legna in vigneti e frutteti.

*The Multi-purpose ALPEGO flail-mowers are the working tool ideal in all situations, with the best results and the max. security: for grass mowing and mulching of vines and wood in vineyards and orchards.*

Les broyeurs polyvalents ALPEGO, sont les outils idéals pour travailler dans toutes les conditions avec un maximum de résultats et une sécurité optimale : pour broyer l'herbe, les sarments et bois de taille de vignes et de vergers.



TrisaR  
TR26

40 - 80 HP

Pg. 5



TrisaR  
TR36

45 - 100 HP

Pg. 6



TrisaR  
TR46

55 - 150 HP

Pg. 7

## Gamma / Range / Gamme



# Camera di taglio SSA... Mulching chamber SSA... Chambre de broyage SSA...



Esclusiva Alpego (brevettata) è la nuova camera di taglio SSA "Super Shredder Alpego" a volume variabile; cambiando la posizione del cofano è possibile ottenere due tipi di lavoro.

Exclusive to Alpego is the new SSA "Super Shredder Alpego mulching chamber (patented) whose volume is variable: by changing the position of the rear gate it is possible to obtain two different types of work.

Exclusivité Alpego (brevetée), la nouvelle chambre de broyage SSA "Super Shredder Alpego" à volume variable permet de changer la position du capot arrière et d'obtenir ainsi deux types de travaux.

**A** Sfalcio erba, cespugli, vegetazione fitta.  
Cutting of grass, bushes, thick vegetation.  
Herbe, buissons, végétation épaisse.

**B** Sarmenti, sterpaglia, potature, legna.  
Vines, underbrush, prunings, wood.  
Sarments, chaumes, bois de taille, bois.



Funzione per erba: il cofano rimane chiuso senza "lancio" di prodotto.

Grass mowing: the rear gate remains shut, and the mulched product is not thrown out of the machine.

Fonction pour l'herbe: Le capot reste fermé sans « lancer » de matière.

Funzione per legna Turbostritolatore: con il cofano basso i residui legnosi vengono particolarmente triturati, rimanendo nella camera fino alla massima triturazione.

Turbo-mulcher wood-mulching function: with the rear gate kept low the wooden residues are finely mulched: they remain within the chamber until they are mulched as finely as possible.

Fonction pour le bois TurboBroyage: Avec le capot bas les résidus de bois sont particulièrement broyés, et reste dans la chambre jusqu'au broyage maximal.



Vantaggiosa è la camera di taglio SSA per la versione frontale (TR46); il cofano chiuso salvaguarda il trattore evitando il lancio di materiale.

Thanks to the SSA mulching chamber system, the tractor cannot be damaged even when mounting the TR46 in the front.

Grande chambre de broyage SSA pour la version frontale (TR46). Le coffre fermé préserve le tracteur en évitant la projection de résidus.



TrisaR

TR 26 140 160 180C 200C



Trinciasarmenti per trattori fino a 80HP  
Flailmowers for tractors up to 80HP  
Broyeurs pour tracteurs jusqu' à 80HP

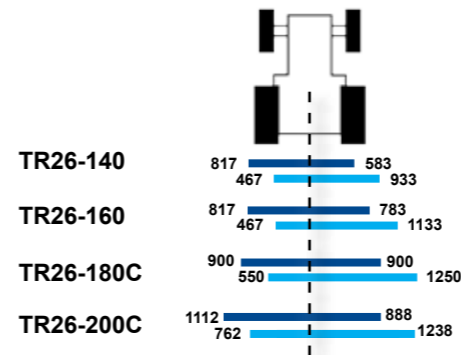
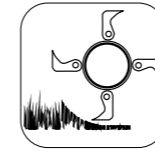

### IT CARATTERISTICHE

- Camera di taglio SSA "Super Shredder Alpego" (brevettata) plurifunzionale a volume variabile: A) funzione per erba a passaggio facilitato; B) funzione per legna Turbostritolatore
- Telaio con lato destro smussato e con protezione laterale
- Contro telaio (doppia lamiera)
- Rotore a mazze con supporti protetti interni
- Ruota libera a bagno d'olio nel moltiplicatore
- Spostamento laterale meccanico o idraulico
- Attacco al trattore di 1° e 2° categoria
- Per sarmenti fino a Ø 5 cm

### GB FEATURES

- Mulching chamber "Super Shredder Alpego" (Patent) designed to allow for an adjustable mulching volume: A) for mulching grass, fast discharge; B) "Turbo-mulching" position for mulching wood
- Frame with rounded right side and side guards
- Double frame (double skin)
- Rotor with flails and imbedded supports
- Free wheel in oil bath positioned inside the main gearbox
- Mechanical or Hydraulic lateral movement
- 3-point hitch, Cat. 1 and 2
- For vines of up to Ø 5 cm

### FR CARACTÉRISTIQUES

- Chambre de broyage à volume variable SSA "Super Shredder Alpego" (brevetée) multi fonction: A) mode herse à évacuation libre B) mode bois avec retour actif
- Châssis avec côté droit profilé doté de protection latérale
- Double tôle de blindage
- Rotor à marteaux avec roulements internes protégés
- Roue libre à bain d'huile intégrée au boîtier
- Déport latéral mécanique ou hydraulique
- Chapes d'attelage de 1°, 2° catégorie
- Pour sarment jusqu'à Ø 5 cm

### DATI TECNICI / TECHNICAL DATA / CARACTÉRISTIQUES TECHNIQUES

	HP	mm	mm	n°	(n°)	mm	KG
TrisaR TR26-140	40-80	1400	1550	12	4	140	424
TrisaR TR26-160	45-80	1600	1750	14	4	140	450
TrisaR TR26-180C	50-80	1800	1950	16	4	140	670
TrisaR TR26-200C	55-80	2000	2150	16	4	140	691

### EQUIPAGGIAMENTO / EQUIPMENT / EQUIPEMENTS

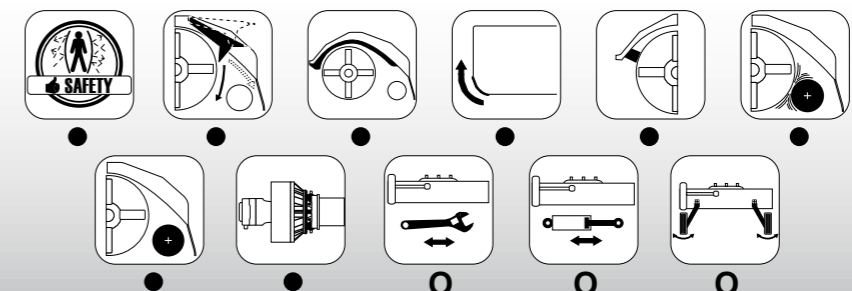

● = di serie - standard - de série  
○ = Option - Optinal - Option

Trinciasarmenti per trattori fino a 100HP  
 Flailmowers for tractors up to 100HP  
 Broyeurs pour tracteurs jusqu' à 100HP

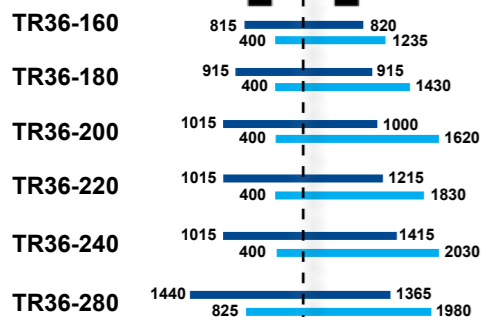
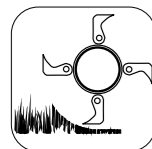

**FR** CARACTÉRISTIQUES

- Chambre de broyage à volume variable SSA "Super Shredder Alpego" (brevetée) multi fonction :  
 A) mode herse à évacuation libre  
 B) mode bois avec retour actif
- Châssis avec côté droite profilé sans obstacle et supports de roulements de rotor internes
- Double tôle de blindage
- Rotor à marteaux renforcé
- Roue libre à bain d'huile intégrée au boîtier
- Déport latéral mécanique ou hydraulique
- Chapes d'attelage de 1°, 2° catégorie
- Pour sarment jusqu'à Ø 8-10 cm

**GB** FEATURES

- Mulching chamber "Super Shredder Alpego" (Patent) designed to allow for an adjustable mulching volume:  
 A) for mulching grass, fast discharge;  
 B) "Turbomulching" position for mulching wood
- Frame with rounded right side with internal rotor supports
- Double frame (double skin)
- Bigger flail rotor
- Free wheel in oil bath positioned inside the main gearbox
- Mechanical or Hydraulic lateral movement
- 3-point hitch, Cat. 1 and 2
- For vines of up to Ø 8-10 cm

**IT** CARATTERISTICHE

- Camera di taglio SSA "Super Shredder Alpego" (brevettata) plurifunzionale a volume variabile:  
 A) funzione per erba a passaggio facilitato;  
 B) funzione per legna Turbo trituratore
- Telaio con lato destro smussato senza ingombri, con supporti rotore interni
- Contro telaio (doppia lamiera)
- Rotore a mazze maggiorato
- Ruota libera a bagno d'olio nel moltiplicatore
- Spostamento laterale meccanico o idraulico
- Attacco al trattore di 1° e 2° categoria
- Per sarmenti fino a Ø 8-10 cm

DATI TECNICI / TECHNICAL DATA / CARACTÉRISTIQUES TECHNIQUES

	HP	mm	mm	(n°)	(n°)	mm	KG
TrisaR TR36-160	45-100	1600	1750	14	4	160	635
TrisaR TR36-180	50-100	1800	1950	16	4	160	675
TrisaR TR36-200	55-100	2000	2150	16	4	160	715
TrisaR TR36-220	60-100	2200	2350	20	4	160	765
TrisaR TR36-240	65-100	2400	2550	20	4	160	802
TrisaR TR36-280M	70-100	2800	2950	24	5	160	900

EQUIPAGGIAMENTO / EQUIPMENT / EQUIPEMENTS

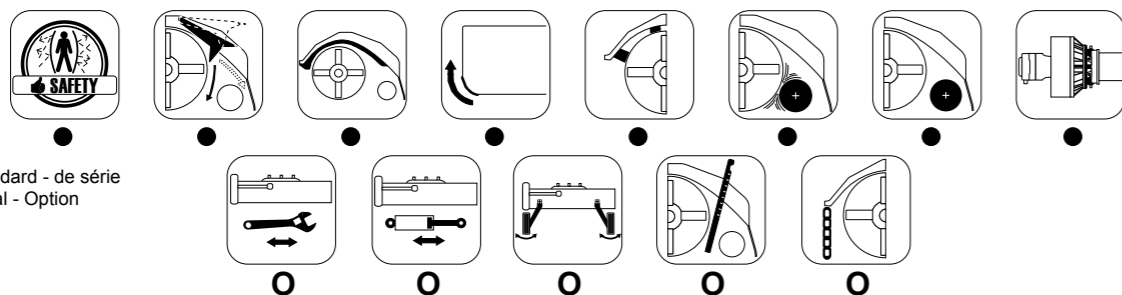

● = di serie - standard - de série  
 ○ = Option - Optinal - Option

Trinciasarmenti per trattori fino a 150HP  
 Flailmowers for tractors up to 150HP  
 Broyeurs pour tracteurs jusqu' à 150HP

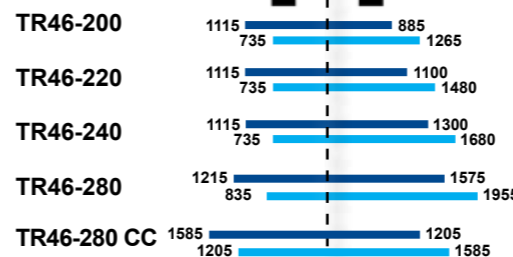

**FR** CARACTÉRISTIQUES

- Chambre de broyage à volume variable SSA "Super Shredder Alpego" (brevetée) multi fonction :  
 A) mode herse à évacuation libre  
 B) mode bois avec retour actif
- Double attelage trois points réversible
- Châssis avec côté droite profilé sans obstacle et supports de roulements de rotor internes
- Double tôle de blindage
- Rotor à marteaux renforcé (TR46-280M)
- Roue libre à bain d'huile intégrée au boîtier
- Déport latéral hydraulique
- Chapes d'attelage de 2° catégorie
- Pour sarment jusqu'à Ø 8-10 cm

**GB** FEATURES

- Mulching chamber "Super Shredder Alpego" (Patent) designed to allow for an adjustable mulching volume:  
 A) for mulching grass, fast discharge;  
 B) "Turbomulching" position for mulching wood
- Double 3 point hitch, movable for frontal and rear application
- Frame with rounded right side with internal rotor supports
- Double frame (double skin)
- Bigger flail rotor (TR46-280M)
- Free wheel in oil bath positioned inside the main gearbox
- Hydraulic lateral movement
- 3-point hitch, Cat. 2
- For vines of up to Ø 8-10 cm

**IT** CARATTERISTICHE

- Camera di taglio SSA "Super Shredder Alpego" (brevettata) plurifunzionale a volume variabile:  
 A) funzione per erba a passaggio facilitato;  
 B) funzione per legna Turbo trituratore
- Doppio attacco a 3 punti Spostabile per applicazione posteriore o frontale
- Telaio con lato destro smussato senza ingombri, con supporti rotore interni
- Contro telaio (doppia lamiera)
- Rotore a mazze maggiorato (TR46-280M)
- Ruota libera a bagno d'olio nel moltiplicatore
- Spostamento laterale idraulico
- Attacco 3 punti di 2° categoria
- Per sarmenti fino a Ø 8-10 cm

DATI TECNICI / TECHNICAL DATA / CARACTÉRISTIQUES TECHNIQUES

	HP	mm	mm	n°	n°	mm	KG
TrisaR TR46-200	55-150	2000	2150	16	4	160	890
TrisaR TR46-220	60-150	2200	2350	20	4	160	960
TrisaR TR46-240	65-150	2400	2550	20	4	160	1030
TrisaR TR46-280CC	70-150	2800	2950	24	5	160	1120

EQUIPAGGIAMENTO / EQUIPMENT / EQUIPEMENTS

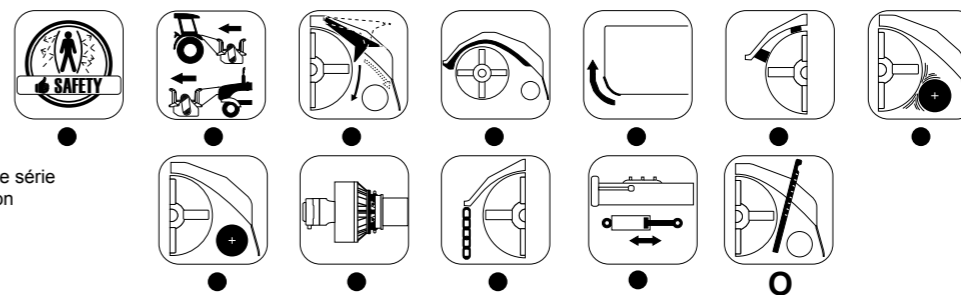

● = di serie - standard - de série  
 ○ = Option - Optinal - Option

# TrisaR

Componenti realizzati con acciaio **SSAB** autoresistenziale.

Manufactured with **SSAB** high tensile steel.

Pièces réalisées avec de l'acier **SSAB** à très haute limite d'élasticité.

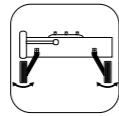

Coppia **ruote posteriori sterzanti**, in alternativa al rullo. (option per TR-26 e TR-36)

Pair of **rear steering wheels** as an alternative to the rear roller. (optional for TR-26 and TR-36)

Paire de **roues arrière pivotantes**, en alternative au rouleau. (option pour TR-26 et TR-36)



MECCANICO

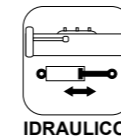

IDRAULICO

Lo **spostamento laterale** delle Trinciasarmenti Alpego può essere a comando manuale o idraulico. (a scelta per TR-26 e TR-36 / di serie idraulico per TR-46)

The **side shift** of the Alpego flail-mowers can be controlled either manually or hydraulically. (to be chosen for TR-26 and TR-36 / Hydraulic standard for TR-46)

Le **déport latéral** des broyeurs Alpego peut être à commande mécanique ou hydraulique. (au choix pour TR-26 et TR-36 / hydraulique de série pour TR-46)

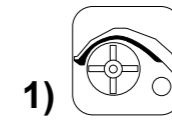
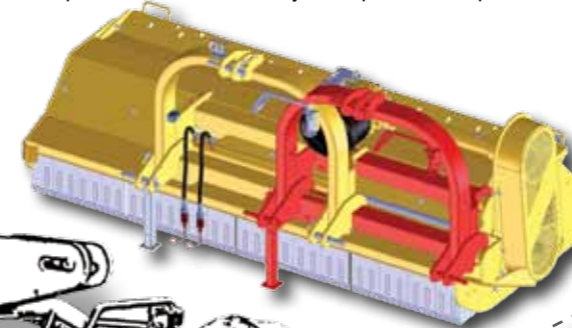

1)

La camera di taglio composta da una scocca **telaio a doppio fondo** incrementa la resistenza ed integrità della macchina evitando danni al cofano.

The **mulching chamber**, consisting of a double metal frame increases the resistance and the integrity of the machine, while protecting the rear gate against damages.

La **chambre de broyage** est dotée d'une double tôle de blindage afin d'augmenter la résistance et de protéger la machine en évitant les coups donnés au capot.

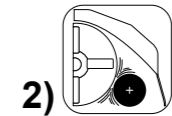
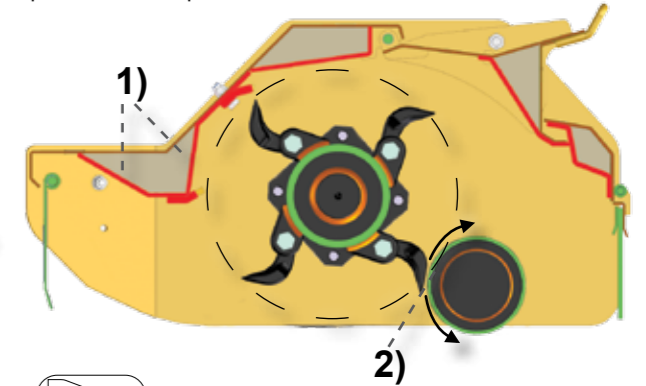

2)

Il **rullo posteriore autopulente**, caratterizzato da un sistema di pulitura automatico del rullo grazie alla pozione molto ravvicinata al rotore.

The **self-cleaning rear roller**, is characterized by an automatic self-cleaning feature thanks to its position very close to the rotor.

Le **rouleau arrière autonettoyant** est équipé d'un système de nettoyage automatique grâce à sa position très proche du rotor.

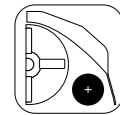

**Rullo posteriore** regolabile in 2 posizioni, con profilo laterale antingolfamento che permette lo scarico del prodotto trinciato dietro al rullo. I cuscinetti posizionati internamente alla fiancata sono protetti.

**Rear roller** adjustable in 2 positions, with a lateral anti-clogging profile, which makes it possible for the mulched product to be discharged beyond the rear roller. The bearings, housed within the side of the machine frame are protected.

**Rouleau de terrage** réglable en 2 positions, avec profil latéral anti-bourrage qui permet le passage des résidus broyés derrière le rouleau. Les roulements montés à l'intérieur des flancs sont protégés.

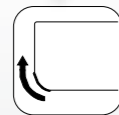

**Telaio smussato** con scudo laterale.

**Rounded frame** with a lateral shield.

**Châssis profilé** avec protection latérale.



**Pettine raccogliatore**, per raccogliere i tralci. (option per TR-36 e TR-46).

**Vine-gathering comb**, to collect the vines. (optional for TR-36 and TR-46).

**Peignes à sarments**, pour récupérer les bois de taille. (option pour TR-36 et TR-46).

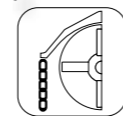

**Kit catene anteriori** in alternativa alle bandelle per un impiego più gravoso. (option per TR-36 / di serie per TR-46)

**Set of front chains** as an alternative to the metal shields for heavy duty use. (optional for TR-36 / standard for TR-46)

**Chaines de protection avant** en alternative aux plaques pour une utilisation plus intensive. (option pour TR-36 / de série pour TR-46)

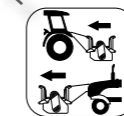

Il sistema **doppio attacco reversibile** dei Trincia TR46 permette alla macchina un'applicazione sia frontale che posteriore.

The **reversible double hitch** of the TR46 flail-mower makes it possible for the machine to be used both in front and at the rear of the tractor.

Le système **d'attelage double réversible** des broyeurs TR46 une application frontale ou arrière rapide.



**Kit doppio controcoltello**, per migliorare la frantumazione dei residui colturali, con **Rotore** a mazze maggiorato con bulloni M18. (di serie per TR-36 e TR-46)

**Set of double counter blade** in order to improve the mulching of the vegetation residues with an over-large hammer-supporting rotor and M18 bolts. (standard for TR-36 and TR-46)

Le kit **double contre-couteaux** offre un meilleur fractionnement des résidus de culture avec le rotor à marteaux renforcés fixés avec des boulons M18. (de série pour TR-36 et TR-46)

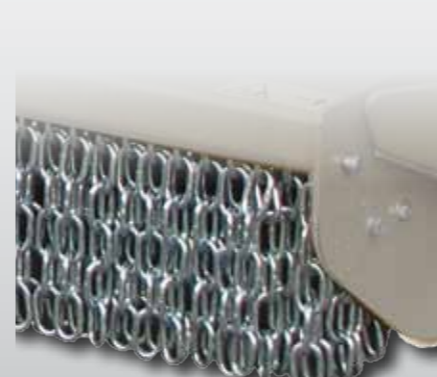

# TriLat

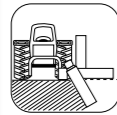

I **Trincia Laterali** sono lo strumento ideale per la manutenzione di: fossati, bordi stradali, prati, pulizia di argini e siepi.

*The lateral flail mowers are the ideal tools for the maintenance of ditches, road sides, meadows and the clearing of banks and clipping of hedges.*

Les **broyeurs d'accotements** sont les outils idéals pour l'entretien des fossés, bords de routes, chemins, bords d'étangs ou des haies.

TrisaR



Pag. 5

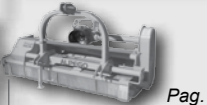

Pag. 6



Pag. 7



Pag. 13



Pag. 14



Pag. 15

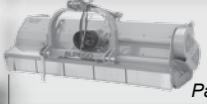

Pag. 20

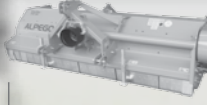

Pag. 21

TriLat

TrisToc



TriLat  
TL18

30 - 60 HP

Pg. 13



TriLat  
TL31

50 - 130 HP

Pg. 14



TriLat  
TL33

50 - 130 HP

Pg. 15

## Gamma / Range / Gamme



**Trinciatrici laterali per trattori fino a 60HP**  
**Lateral flail mowers for tractors up to 60HP**  
**Broyeurs d'accotements pour tracteurs jusqu'à 60HP**

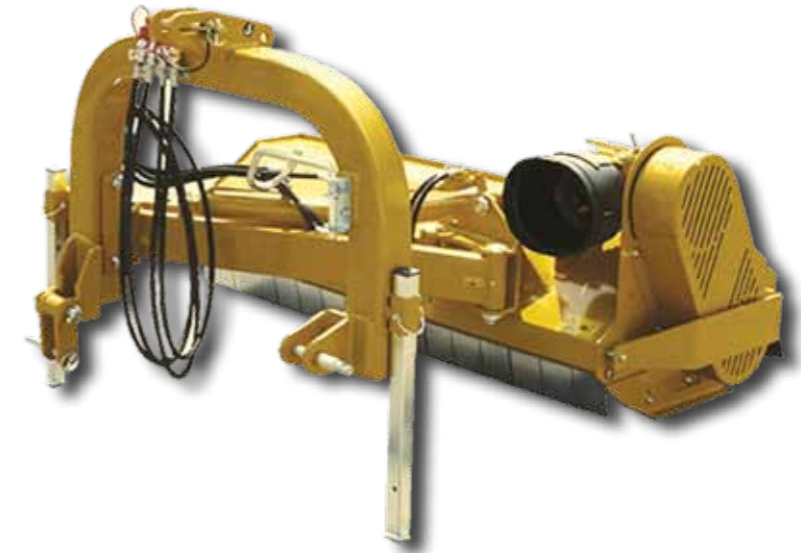
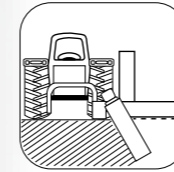

# PERCHÉ IL TRILAT ALPEGO... WHY AN ALPEGO TRILAT... POURQUOI UNE TRILAT ALPEGO..

## Spostamento / Sideshift / Déport

Versatile è lo spostamento idraulico dei Trincia laterali, adatto a lavorare sia posteriormente che lateralmente alla trattoria.

The hydraulic sideshift of the lateral flail mowers is very versatile and suited to work both behind and at the side of the tractor.

Le déport hydraulique des broyeurs d'accotements est très polyvalent en permettant un mouvement arrière et latéral par rapport au tracteur.

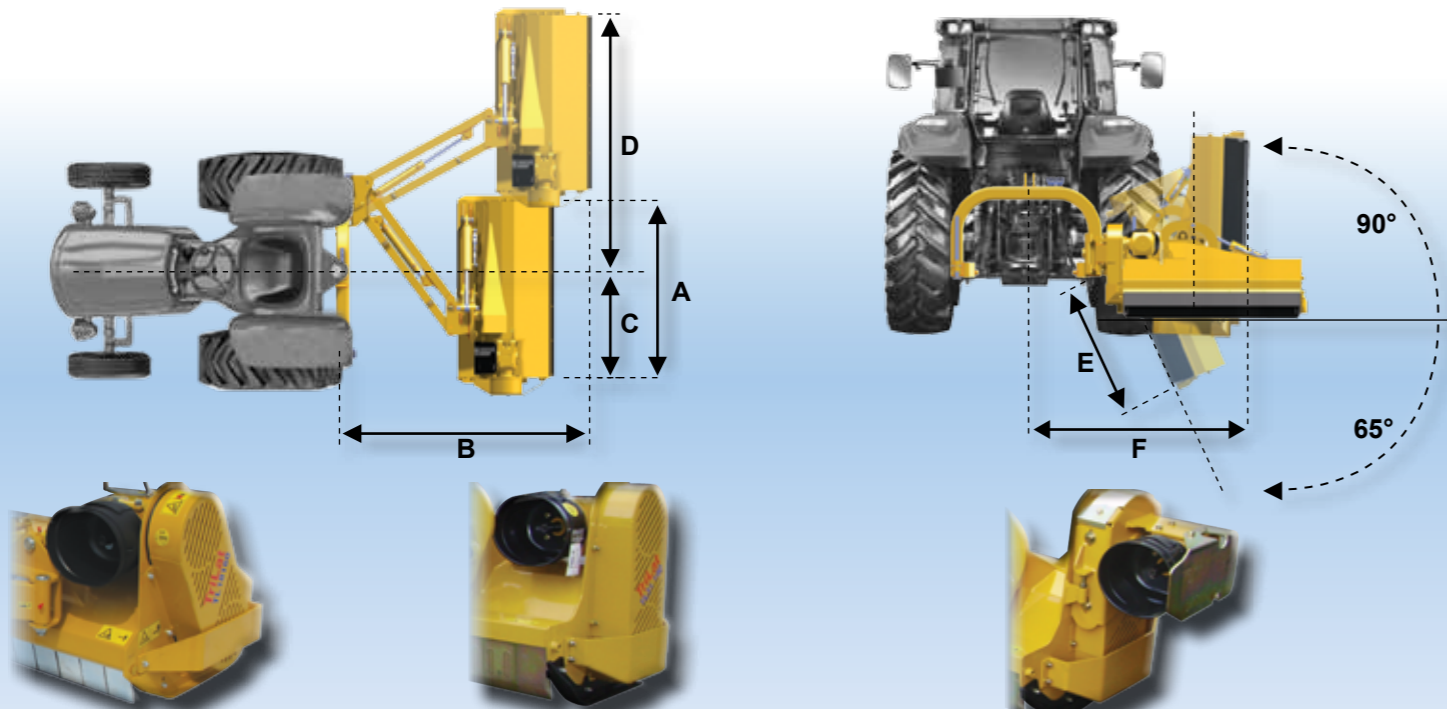

	TL18-120	TL18-140	TL18-160
A (mm)	1200	1400	1600
B (mm)	1500	1500	1500
C (mm)	570	570	570
D (mm)	1810	2010	2210
E (mm)	900	1100	1300

	TL31-140	TL31-160	TL31-180	TL31-200
A (mm)	1400	1600	1800	2000
B (mm)	1820	1820	1860	1860
C (mm)	770	770	770	770
D (mm)	2150	2350	2550	2750
E (mm)	730	930	1130	1330
F (mm)	1700	1700	1700	1700

	TL33-140	TL33-160	TL33-180	TL33-200
A (mm)	1400	1600	1800	2000
B (mm)	1820	1820	1860	1860
C (mm)	580	580	580	580
D (mm)	2340	2540	2740	2940
E (mm)	900	1100	1300	1500
F (mm)	1700	1700	1700	1700

## FR CARACTÉRISTIQUES

- Chapes d'attelage avec système oscillant
- Rotor à marteaux
- Roue libre à bain d'huile intégrée au boîtier
- Déport et inclinaison hydraulique du tracteur
- Attelage 3 points catégorie 1 et 2 à chapes
- Pour sarment jusqu'à Ø 3 cm

## GB FEATURES

- Linkage with oscillating system
- Rotor comes standard with flails
- Free wheel in oil bath positioned inside the main gearbox
- Hydraulic lateral and vertical movements
- 3-point hitch, Cat. 1 and 2, fork-shaped links
- For vines of up to Ø 3 cm

## IT CARATTERISTICHE

- Attacco al trattore con sistema oscillante
- Rotore a mazze
- Ruota libera a bagno d'olio nel moltiplicatore
- Spostamento ed inclinazione idraulico dal trattore
- Attacco 3 punti di 1° e 2° categoria a forcella
- Per sarmenti fino a Ø 3 cm

## DATI TECNICI / TECHNICAL DATA / CARACTÉRISTIQUES TECHNIQUES

	HP	mm	mm	(n°)	(n°)	mm	KG
TriLat TL18-120	30-60	1200	1350	16	3	140	405
TriLat TL18-140	45-60	1400	1550	20	3	140	415
TriLat TL18-160	50-60	1600	1750	22	3	140	455

## EQUIPAGGIAMENTO / EQUIPMENT / EQUIPAGGIAMENTO / EQUIPEMENTS

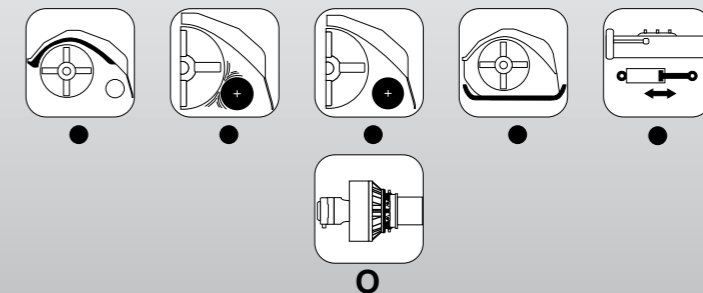

● = di serie - standard - de série  
 ○ = Option - Optinal - Option

Trinciatrici laterali professionali per trattori fino a 130HP  
Professional lateral flail mowers for tractors up to 130HP  
Broyeurs d'accotements professionnels pour tracteurs jusqu' à 130HP

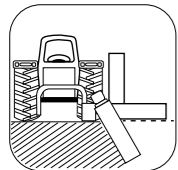

**FR** CARACTÉRISTIQUES

**GB** FEATURES

**IT** CARATTERISTICHE

- Attacco a 3 punti con sistema di sicurezza antiurto elastico "No-Stop"
- **Speciale ammortizzatore idraulico Autolineante sull'asse di ribaltamento**
- Inclinazione idraulica con valvola di sicurezza
- Contro telaio interno (doppia lamiera)
- Rotore con mazze e viti maggiorate
- Ruota libera a bagno d'olio nel moltiplicatore
- Valvole controllo velocità movimento cilindri
- Spostamento laterale idraulico maggiorato con valvola di blocco
- Attacco 3 punti di 2° categoria a forcella
- Per sarmenti fino a Ø 6 cm

- 3-point hitch with "No-Stop" elastic anti-shock safety system
- **Special self-levelling hydraulic shock absorber**
- Hydraulic tilting with safety valve
- Double frame (double skin)
- Rotor with flails and larger bolts
- Free wheel in oil bath positioned inside the main gearbox
- Valves for the speed control of the hydraulic cylinders
- Extended hydraulic lateral movement with blocking valve
- 3-point hitch, Cat.2 with fork-shaped links
- For vines of up to Ø 6 cm

- Attelage 3 points avec système de sécurité anti-choc élastique "No-Stop"
- **Spécial amortisseur hydraulique auto-alignant sur l'axe de gavage**
- Inclinaison hydraulique avec vanne de sécurité
- Double tôle de blindage
- Rotor avec marteaux et boulons de fixation renforcés
- Roue libre à bain d'huile intégrée au boîtier
- Vanne de contrôle de la vitesse d'action des vérins
- Déport latéral hydraulique majoré avec vanne de blocage
- Attelage 3 point catégorie 2 à chapes
- Pour sarment jusqu'à Ø 6 cm

DATI TECNICI / TECHNICAL DATA / CARACTÉRISTIQUES TECHNIQUES

	HP	mm	mm	(n°)	(n°)	mm	KG
TriLat TL31-160	55-130	1600	1800	14	4	140	670
TriLat TL31-180	65-130	1800	2000	16	4	140	710
TriLat TL31-200	75-130	2000	2200	16	4	140	740
TriLat TL31-220	75-130	2200	2200	16	4	140	780

EQUIPAGGIAMENTO / EQUIPMENT / EQUIPEMENTS

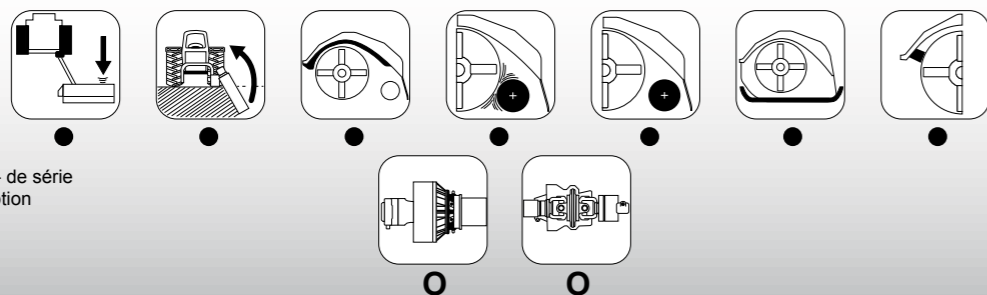

● = di serie - standard - de série  
○ = Option - Optinal - Option

Trinciatrici laterali professionali per trattori fino a 130HP  
Professional lateral flail mowers for tractors up to 130HP  
Broyeurs d'accotements professionnels pour tracteurs jusqu' à 130HP

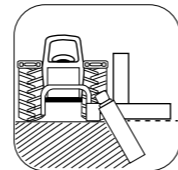

**FR** CARACTÉRISTIQUES

**GB** FEATURES

**IT** CARATTERISTICHE

- Gruppo moltiplicatore montato all'esterno
- Attacco a 3 punti con sistema di sicurezza antiurto elastico "No-Stop"
- **Speciale ammortizzatore idraulico Autolineante sull'asse di ribaltamento**
- Inclinazione idraulica con valvola di sicurezza
- Contro telaio interno (doppia lamiera)
- Rotore con mazze e viti maggiorate
- Ruota libera a bagno d'olio nel moltiplicatore
- Valvole controllo velocità movimento cilindri
- Spostamento laterale idraulico maggiorato con valvola di blocco
- Attacco 3 punti di 2° categoria a forcella
- Per sarmenti fino a Ø 6 cm

- Gearbox externally positioned
- 3-point hitch with "No-Stop" elastic anti-shock safety system
- **Special self-levelling hydraulic shock absorber**
- Hydraulic tilting with safety valve
- Double frame (double skin)
- Rotor with flails and larger bolts
- Free wheel in oil bath positioned inside the main gearbox
- Valves for the speed control of the hydraulic cylinders
- Extended hydraulic lateral movement with blocking valve
- 3-point hitch, Cat.2 with fork-shaped links
- For vines of up to Ø 6 cm

- Boîtier monté à l'extérieur
- Attelage 3 points avec système de sécurité anti-choc élastique "No-Stop"
- **Spécial amortisseur hydraulique auto-alignant sur l'axe de gavage**
- Inclinaison hydraulique avec vanne de sécurité
- Double tôle de blindage
- Rotor avec marteaux et boulons de fixation renforcés
- Roue libre à bain d'huile intégrée au boîtier
- Vanne de contrôle de la vitesse d'action des vérins
- Déport latéral hydraulique majoré avec vanne de blocage
- Attelage 3 point catégorie 2 à chapes
- Pour sarment jusqu'à Ø 6 cm

DATI TECNICI / TECHNICAL DATA / CARACTÉRISTIQUES TECHNIQUES

	HP	mm	mm	(n°)	(n°)	mm	KG
TriLat TL33-160	55-130	1600	2100	14	4	140	700
TriLat TL33-180	65-130	1800	2300	16	4	140	740
TriLat TL33-200	75-130	2000	2500	16	4	140	760
TriLat TL33-220	75-130	2200	2500	16	4	140	800

EQUIPAGGIAMENTO / EQUIPMENT / EQUIPEMENTS

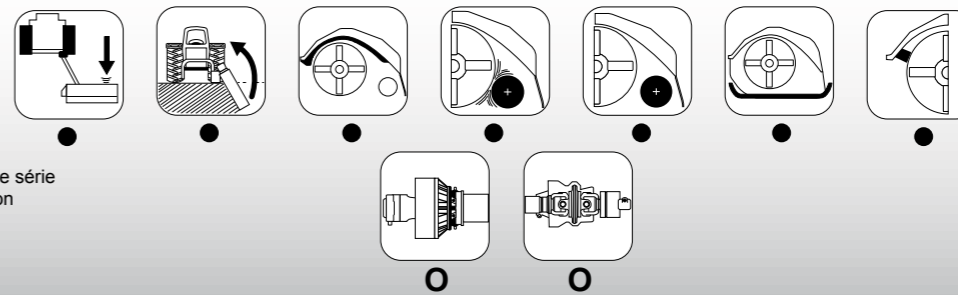

● = di serie - standard - de série  
○ = Option - Optinal - Option



# TriLat

Componenti realizzati con acciaio **SSAB** autoresistenziale.

Manufactured with **SSAB** high tensile steel.

Pièces réalisées avec de l'acier **SSAB** à très haute limite d'élasticité.

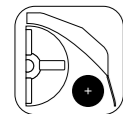
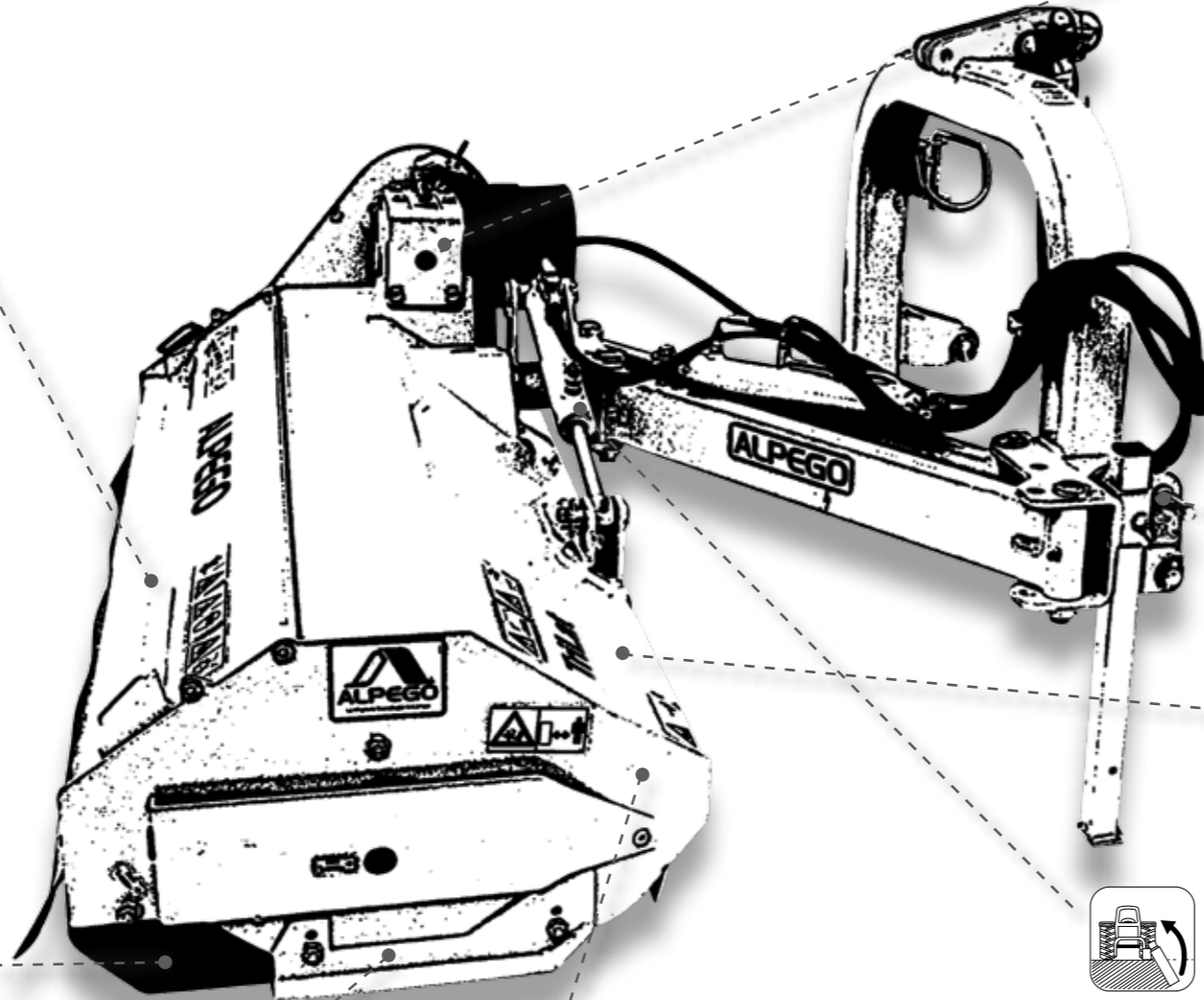

**Rullo posteriore** con profilo laterale antingolfamento che permette lo scarico del prodotto trinciato dietro al rullo. I cuscinetti posizionati internamente alla fiancata, sono protetti.

**Rear roller** with a lateral anti-clogging profile, which permits the discharge of the mulched product beyond the roller. The bearings housed within the lateral frame of the machine are protected.

**Rouleau de terrage** avec protection latérale anti-bourrage qui permet le passage des résidus broyés derrière le rouleau. Les roulements montés à l'intérieur des flancs sont protégés.



Kit **coppia slitte**.

Set of a **pair of skids**.

**Paire de patins**.

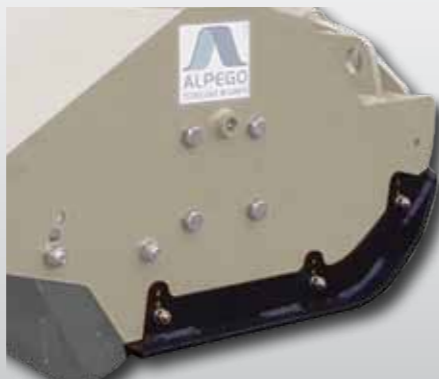

**Rotore** a mazze maggiorato con bulloni M18. (non per TL-18).

Oversize **rotor** with hammers held by M18 bolts. (not for TL-18).

**Rotor** à marteaux renforcé fixés avec des boulons M18. (suf TL-18)



Il nuovo sistema **ammortizzante idraulico autolivellante** sull'asse di ribaltamento permette un uso facilitato della macchina in presenza di ostacoli e condizioni particolari del terreno. Inoltre salvaguarda l'intero sistema di ribaltamento della macchina attenuando gli urti prodotti durante le operazioni di lavoro. (di serie per TL-31 e TL-33)

The new **hydraulic shock-dampening, self-leveling** system positioned on the tilting axis permits an easier use of the machine when there are obstacles and particularly difficult soil conditions. Moreover it protects the entire tilting system of the machine while dampening the shocks caused during the working operation. (standard for TL-31 and TL-33)

Le nouveau système **amortisseur hydraulique auto nivelant** monté sur l'axe de gavage permet un usage facilité de la machine en présence d'obstacles et de conditions particulières du terrain. En plus de préserver le système de gavage, ce procédé permet d'atténuer les coups produits lors du travail. (de série pour TL-31 et TL-33)

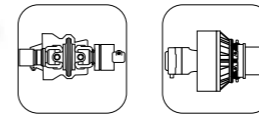

**Doppio cardano di trasmissione Omocinetico Walterscheid**: maggiore regolarità e sicurezza in spostamento anche con angoli di lavoro particolarmente elevati. (a scelta per TL-31 e TL-33)

**Double Walterscheid wide angle drive shaft** for a better regularity and security of the shifting even when the working tilt is especially steep. (to be chosen for TL-31 and TL-33)

**Cardan de transmission double homocinétique Walterscheid** : améliore la régularité et la sécurité lors des déports même avec des angles de travail élevés. (au choix pour TL-31 et TL-33)

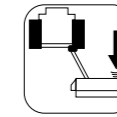
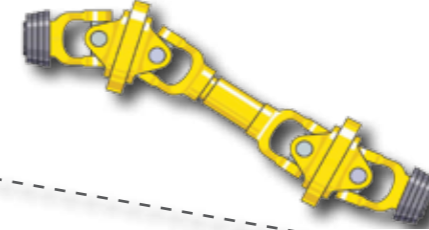

Sistema di **sicurezza antiurto elastico "No-Stop"**, in presenza di ostacoli non visibili il dispositivo entrerà in funzione bloccando la cassa trinciante e ammortizzando il colpo. (di serie per TL-31 e TL-33)

**"No stop" Elastic anti-shock safety system.** When there are hidden obstacles the system is triggered and it blocks the mulching chamber and dampens the shock. (standard for TL-31 and TL-33)

Système de **sécurité anti-choc élastique "No-Stop"**. EN présence d'obstacles non visibles, ce dispositif entre en fonction automatiquement en bloquant le lamier et en amortissement le choc. (de série pour TL-31 et TL-33)



1) 1)

La camera di taglio composta da una scocca **telaio a doppio fondo** incrementa la resistenza ed integrità della macchina evitando danni al cofano.

The **mulching chamber**, consisting of a **double metal frame** increases the resistance and the integrity of the machine, while protecting the rear gate against damages.

La **chambre de broyage** est dotée d'une double tôle de blindage afin d'augmenter la résistance et de protéger la machine en évitant les coups donnés au capot.

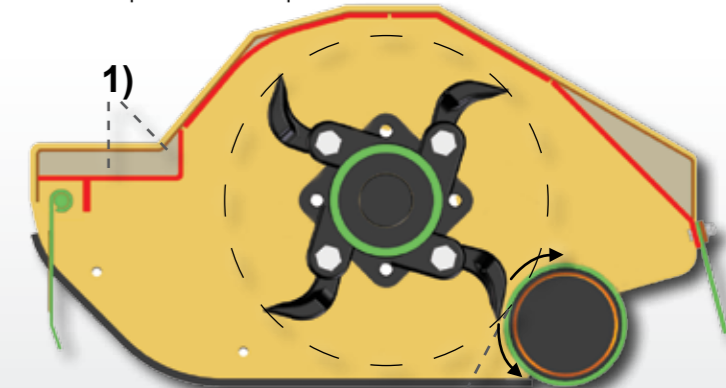

2) 2)

Il **rullo posteriore autopulente**, caratterizzato da un sistema di pulitura automatica del rullo grazie alla posizione molto ravvicinata al rotore.

The **self-cleaning rear roller**, is characterized by an automatic self-cleaning feature thanks to its position very close to the rotor.

Le **rouleau arrière autonettoyant** est équipé d'un système de nettoyage automatique grâce à sa position très proche du rotor.



Pag. 5

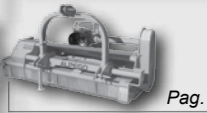

Pag. 6



Pag. 7



Pag. 13



Pag. 14



Pag. 15



Pag. 20



Pag. 21

# TrisToc

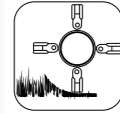

I **Trinciastocchi** Alpego grazie alla loro robustezza sono lo strumento ideale per sminuzzare e tritare in campo aperto: arbusti, paglia, stoppie di mais, soia, residui del raccolto, materiale legnoso o organico presente sul terreno incolto.

*The Alpego shredders, thanks to their sturdiness are the ideal tool to mulch and shred in the open field: bushes, straw, corn stocks, soy and crop residues, wooden or organic material present on fallow soils.*

Les **broyeurs cultures** Alpego sont grâce à leur robustesse les outils idéals pour le broyage et l'entretien en plein champs : arbustes, paille, tiges de maïs, soja, résidus de récolte, matière organique ou bois présents les jachères.



**TrisToc  
TT93**

40 - 100 HP

Pg. 20



**TrisToc  
TT97**

80 - 160 HP

Pg. 21

## Gamma / Range / Gamme



# TrisToc TT93

160 200 230 250

Trinciasocchi per trattori fino a 100HP  
 Shredders for tractors up to 100HP  
 Broyeurs culture pour tracteurs jusqu' à 100HP

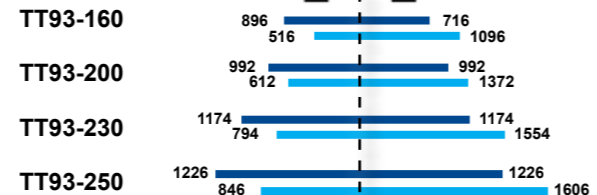

## IT CARATTERISTICHE

- Trinciasocchi con portello apribile per manutenzione e telaio monoscocca con spostamento
- Telaio senza ingombri esterni con supporti rotore interni
- Rotore a coltelli curvi o mazze
- Ruota libera a bagno d'olio nel moltiplicatore
- Minigonne laterali
- Spostamento laterale meccanico o idraulico
- Attacco 3 punti di 2° categoria spostabile

## GB FEATURES

- Straw mowers with movable rear for maintenance and monocoque mainframe with lateral movement
- Frame without jutting parts and with inner rotor supports
- Machine with a bent blades or flails rotor
- Free wheel in oil bath positioned inside the main gearbox
- Side plates
- Mechanical or hydraulic laterla movement
- 3-point hitch, Cat. 2 movable

## FR CARACTÉRISTIQUES

- Broyeur cultures avec capot ouvrable pour l'entretien et châssis monocoque avec déport
- Châssis sans encombrement externe avec support de rotor internes
- Rotor à couteaux courbes ou à marteaux
- Roue libre à bain d'huile intégrée au boîtier
- Jupes latérales
- Déport latéral mécanique ou hydraulique
- Attelage 3 points catégorie 2° ajustable

## DATI TECNICI / TECHNICAL DATA / CARACTÉRISTIQUES TECHNIQUES

	HP	mm	mm	(n°)	(n°)	(n°)	mm	KG
TrisToc TT93-160	40-100	1600	1785	32	16	3	220	600
TrisToc TT93-200	50-100	2000	2150	40	20	4	220	700
TrisToc TT93-230	60-100	2300	2520	48	24	4	220	782
TrisToc TT93-250	70-100	2500	2730	52	26	4	220	830

## EQUIPAGGIAMENTO / EQUIPMENT / EQUIPEMENTS

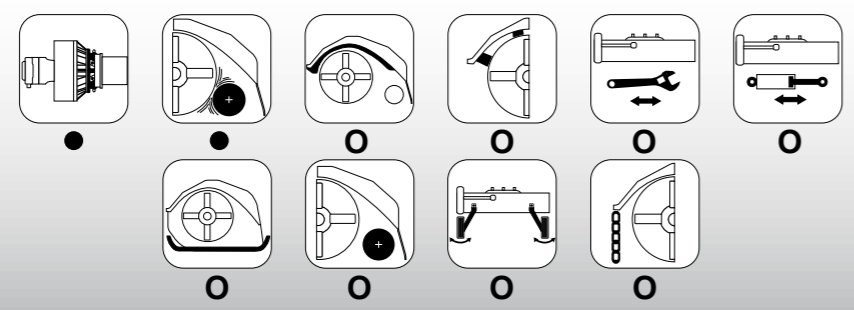

● = di serie - standard - de série  
 ○ = Option - Optinal - Option

# TrisToc TT97

280 300 320

Trinciasocchi per trattori fino a 160HP  
 Shredders for tractors up to 160HP  
 Broyeurs culture pour tracteurs jusqu' à 160HP



## IT CARATTERISTICHE

- Telaio in monoscocca senza giunti e saldature a vista
- Portello apribile per manutenzione
- Telaio senza ingombri esterni con supporti rotore interni
- Rotore a coltelli curvi o mazze
- Ruota libera a bagno d'olio nel moltiplicatore
- Minigonne laterali
- Attacco 3 punti di 2° categoria

## GB FEATURES

- Monocoque frame, no welding and joints visible
- Rear door can be opened for maintenance
- Frame without jutting parts and with inner rotor supports
- Machine with a bent blades or flails rotor
- Free wheel in oil bath positioned inside the main gearbox
- Side plates
- 3-point hitch, Cat. 2

## FR CARACTÉRISTIQUES

- Châssis monocoque sans joint ni soudure visible
- Capot arrière ouvrable pour l'entretien
- Châssis sans encombrement externe avec support de rotor internes
- Rotor à couteaux courbes ou à marteaux
- Roue libre à bain d'huile intégrée au boîtier
- Jupes latérales
- Attelage 3 points de 2° catégorie

## DATI TECNICI / TECHNICAL DATA / CARACTÉRISTIQUES TECHNIQUES

	HP	mm	mm	(n°)	(n°)	(n°)	mm	KG
TrisToc TT97-280	80-160	2800	3000	60	30	5	220	1050
TrisToc TT97-300	90-160	3000	3200	64	32	5	220	1100
TrisToc TT97-320	100-160	3200	3400	68	34	5	220	1130

## EQUIPAGGIAMENTO / EQUIPMENT / EQUIPEMENTS

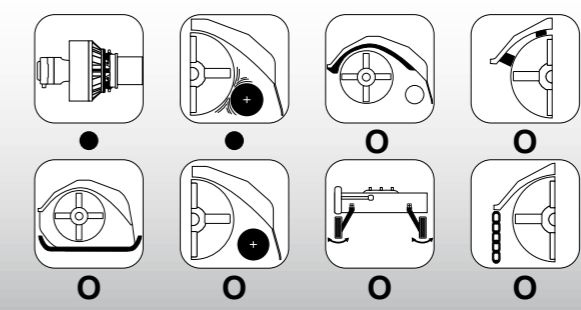

● = di serie - standard - de série  
 ○ = Option - Optinal - Option

# TrisToc

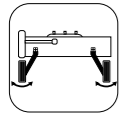

Coppia ruote posteriori sterzanti.  
(option per TT-93 e TT-97)

Pair of rear steering wheels.  
(optional for TT-93 and TT-97)

Paire de roues arrière pivotantes.  
(option pour TT-93 et TT-97)



Rullo posteriore regolabile in 2 posizioni, con profilo laterale antingolfamento che permette lo scarico del prodotto trinciato dietro al rullo. I cuscinetti posizionati internamente alla fiancata, sono protetti. (option per TT-93 e TT-97)

Rear roller adjustable in 2 positions, with a lateral anti-clogging profile, which makes it possible for the mulched product to be discharged beyond the rear roller. The bearings, housed within the side of the machine frame are protected. (optional for TT-93 and TT-97)

Rouleau de terrage réglable en 2 positions, avec profil latéral anti-bourrage qui permet le passage des résidus broyés derrière le rouleau. Les roulements montés à l'intérieur des flancs sont protégés. (option pour TT-93 et TT-97)



Kit coppia slitte.  
(option per TT-93 e TT-97)

Set of a pair of skids.  
(optional for TT-93 and TT-97)

Paire de patins.  
(option pour TT-93 et TT-97)

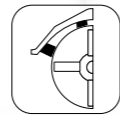
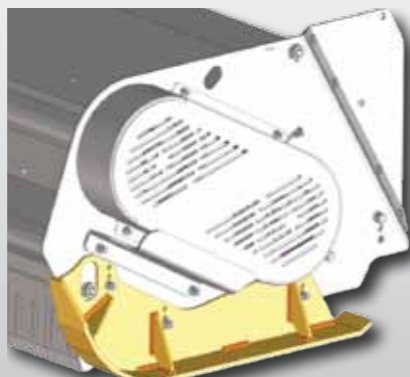

Kit doppio controcoltello per migliorare la frantumazione dei residui colturali.  
(option per TT-93 e TT-97)

Set of double counter blade in order to improve the mulching of the vegetation residues.  
(optional for TT-93 and TT-97)

Le kit double contre-couteaux offre un meilleur fractionnement des résidus de culture.  
(option pour TT-93 et TT-97)

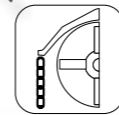

Kit catene anteriori in alternativa alle bandelle per un impiego più gravoso.  
(option per TT-93 e TT-97)

Set of front chain as an alternative to the metal shields for heavy-duty use.  
(optional for TT-93 and TT-97)

Chaines de protection avant en alternative aux plaques pour une utilisation plus intensive.  
(option pour TT-93 et TT-97)

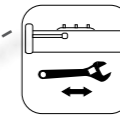
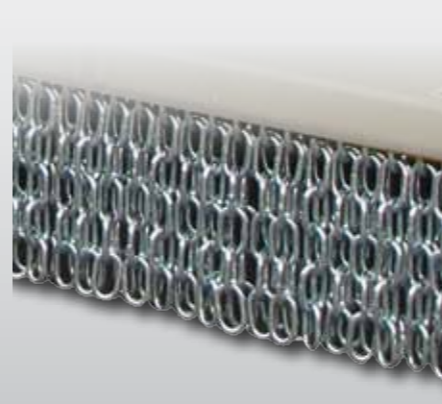

MECCANICO

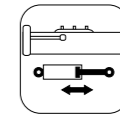

IDRAULICO

Lo spostamento laterale dei Trinciastocchi Alpego può essere a comando manuale o idraulico. (a scelta per TT-93)

The sideshift of the Alpego shredders can be controlled either manually or hydraulically. (to be chosen for TT-93)

Le déport latéral des broyeurs culture Alpego peut être à commande mécanique ou hydraulique. (au choix pour TT-93)

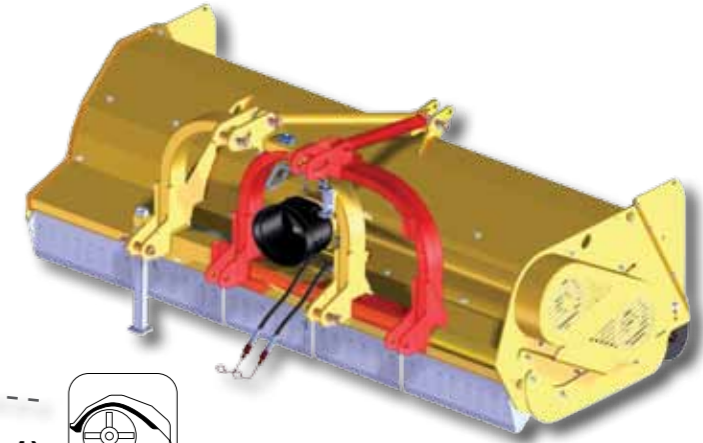

1)



La robusta camera di taglio costruita con telaio a doppio fondo, per incrementare la resistenza ed integrità della macchina evita danni al cofano, (option per TT-93 e TT-97), e controcoltello di serie.

The sturdy mulching chamber built with a double metal frame in order to increase the resistance and the integrity of the machine, prevents damages to the rear gate, (optional for TT-93 and TT-97), and presents a counter-blade supplied standard.

La robuste chambre de broyage est dotée d'un châssis avec double tôle de blindage afin de d'accroître la résistance et la solidité de la machine et d'éviter tout dommage au carter, (option pour TT-93 et TT-97). Elle est aussi équipée de série de contre-couteaux.

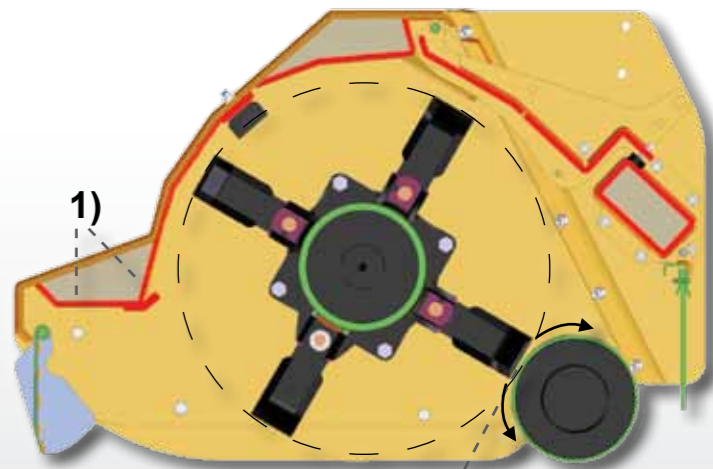

1)



2)

Il rullo posteriore autopulente, è caratterizzato da un sistema di pulizia automatica del rullo grazie alla posizione molto ravvicinata al rotore.

The self-cleaning rear roller, is characterized by an automatic self-cleaning feature thanks to its position very close to the rotor.

Le rouleau arrière autonettoyant est équipé d'un système de nettoyage automatique grâce à sa position très proche du rotor.

# *The best Technology in the Field*

## ERPICI ROTANTI

Power harrows / Herses rotatives



1.10 - 8.00 mt  
50 - 500 HP

## FRESATRICI

Rotary cultivators / Fraises rotatives



1.60 - 4.00 mt  
50 - 240 HP

## PREPARATORE A DISCHI

Disc cultivator / Déchaumeurs à disques



2.50 - 8.00 mt  
80 - 400 HP

## SEMINATRICI

Seed-drills / Semoirs

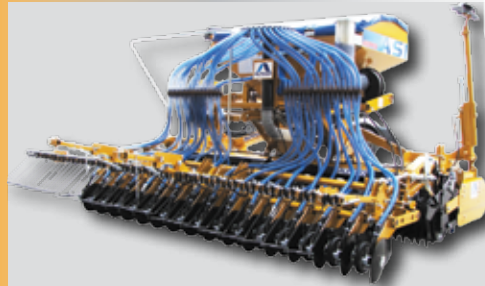

2.50 - 8.00 mt  
80 - 500 HP

## RIPUNTATORI

Subsoilers / Décompacteurs



1.60 - 5.00 mt  
80 - 500 HP

## COLTIVATORI

Cultivators / Déchaumeurs



3.00 - 5.00 mt  
120 - 320 HP

Immagine e dati inseriti nel presente catalogo non sono impegnativi e possono essere modificati in ogni momento senza obbligo di preavviso.  
Images and texts here represented cannot be considered binding and can be modified at manufacturer's discretion.  
Les images et données techniques contenues dans ce catalogue ne sont pas contractuelles. Nous réservons de droit de modifier à tout moment nos machines et leurs accessoires.

Q10A00210/3 - DEPLIANT "GAMMA Trinciarmenti"  
IT-GB-FR 22/01/2018



**Alpego S.p.a**  
Via Giovanni e Giuseppe Cenzato,9  
36045 Lonigo (VI) Italy  
Tel. +39 0444646100  
Fax: +39 0444646199  
[www.alpego.com](http://www.alpego.com)  
[info@alpego.com](mailto:info@alpego.com)

Copyright © by ALPEGO